

### Description

The XPX80P02RX uses advanced trench technology to provide excellent  $R_{DS(ON)}$ , low gate charge and operation with gate voltages as low as 2.5V. This device is suitable for use as a Battery protection or in other Switching application.

### General Features

$V_{DS} = -20V$   $I_D = -80A$

$R_{DS(ON)} < 4m\Omega$  @  $V_{GS}=4.5V$

### Application

Battery protection

Load switch

Uninterruptible power supply

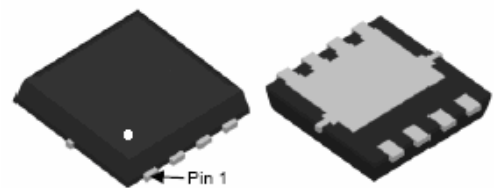
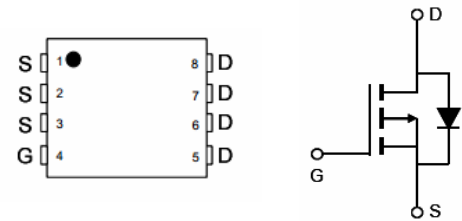

### Package Marking and Ordering Information

Product ID	Pack	Marking	Qty(PCS)
XPX80P02RX	PDFN3*3-8L	XPX80P02RX XXX YYYY	5000

### Absolute Maximum Ratings ( $T_C=25^\circ C$ unless otherwise noted)

Symbol	Parameter	Rating	Units
VDS	Drain-Source Voltage	-20	V
VGS	Gate-Source Voltage	$\pm 12$	V
$I_D@T_C=25^\circ C$	Continuous Drain Current, $V_{GS} @ -4.5V^1$	-80	A
$I_D@T_C=70^\circ C$	Continuous Drain Current, $V_{GS} @ -4.5V^1$	-44	A
IDM	Pulsed Drain Current <sup>2</sup>	-300	A
EAS	Single Pulse Avalanche Energy	180	mJ
$P_D@T_C=25^\circ C$	Total Power Dissipation <sup>3</sup>	43.1	W
TSTG	Storage Temperature Range	-55 to 150	$^\circ C$
TJ	Operating Junction Temperature Range	-55 to 150	$^\circ C$
$R_{\theta JA}$	Thermal Resistance Junction-Ambient <sup>1</sup>	85	$^\circ C/W$
$R_{\theta JC}$	Thermal Resistance Junction-Case <sup>1</sup>	2.9	$^\circ C/W$

**Electrical Characteristics (T<sub>J</sub>=25°C, unless otherwise noted)**

Symbol	Parameter	Test Conditions	Min	Typ	Max	Unit
V(BR)DSS	Drain-Source Breakdown Voltage	VGS = 0V, ID = -250μA	-20	-	-	V
IGSS	Gate-body Leakage current	VDS = 0V, VGS = ±12V	-	-	±100	nA
IDSS	Zero Gate Voltage Drain Current T <sub>J</sub> =25°C	VDS = -20V, VGS = 0V	-	-	-1	μA
IDSS	Zero Gate Voltage Drain Current T <sub>J</sub> =100°C		-	-	-100	
VGS(th)	Gate-Threshold Voltage	VDS = VGS, ID = -250μA	-0.4	-0.7	-1.0	V
RDS(on)	Drain-Source On-Resistance <sup>4</sup>	VGS = -4.5V, ID = -10A	-	4.0	5.5	mΩ
RDS(on)	Drain-Source On-Resistance <sup>4</sup>	VGS = -2.5V, ID = -10A	-	5.0	6.8	
gfs	Forward Transconductance <sup>4</sup>	VDS = -4.5V, ID = -10A	-	56	-	S
Ciss	Input Capacitance	VDS = -10V, VGS = 0V, f = 1MHz	-	4770	-	pF
Coss	Output Capacitance		-	665	-	
Crss	Reverse Transfer Capacitance		-	570	-	
Rg	Gate Resistance	f = 1MHz	-	9.6	-	Ω
Qg	Total Gate Charge	VGS = -4.5V, VDS = -10V, ID = -10A	-	55	-	nC
Qgs	Gate-Source Charge		-	5.2	-	
Qgd	Gate-Drain Charge		-	10	-	
td(on)	Turn-On Delay Time	VGS = -4.5V, VDD = -10V, RG = 3Ω, ID = -10A	-	22	-	ns
tr	Rise Time		-	38	-	
td(off)	Turn-Off Delay Time		-	110	-	
tf	Fall Time		-	62	-	
VSD	Diode Forward Voltage <sup>4</sup>	IS = -10A, VGS = 0V	-	-	-1.2	V
IS	Continuous Source Current	TC=25°C	-	-	-70	A

**Note :**

- 1、 The data tested by surface mounted on a 1 inch 2 FR-4 board with 2OZ copper.
- 2、 The EAS data shows Max. rating. The test condition is VDD=-25V, VGS=-10V, L=0.4mH, IAS = -20A.
- 2、 The data tested by pulsed , pulse width ≅ 300us , duty cycle ≅ 2%
- 3、 The power dissipation is limited by 150°C junction temperature
- 4、 The data is theoretically the same as I<sub>D</sub> and I<sub>DM</sub> , in real applications , should be limited by total power dissipation.

### Typical Characteristics

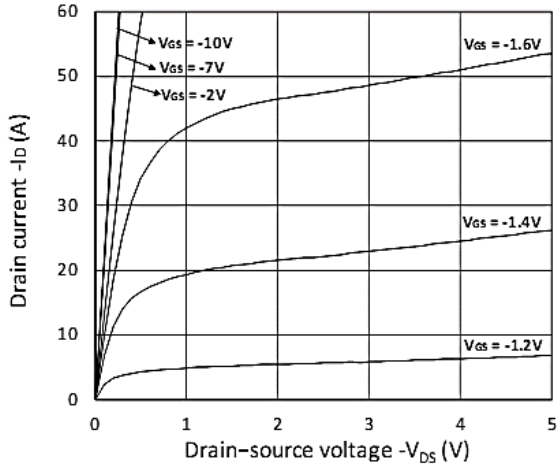

**Figure 1. Output Characteristics**

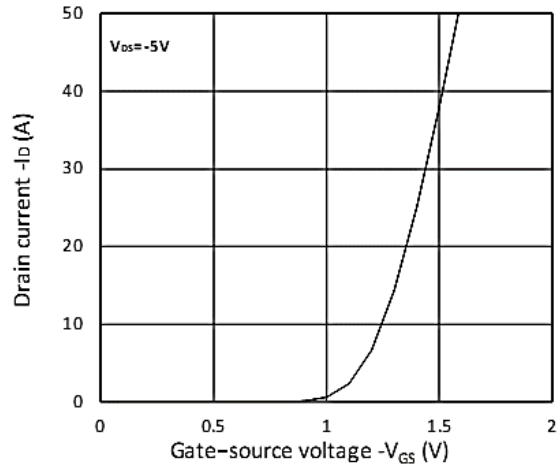

**Figure 2. Transfer Characteristics**

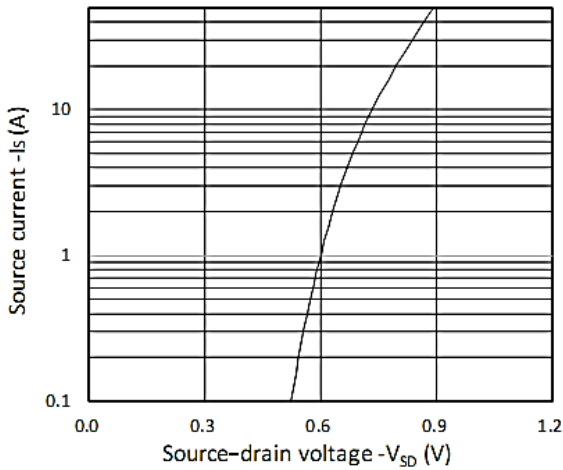

**Figure 3. Forward Characteristics of Reverse**

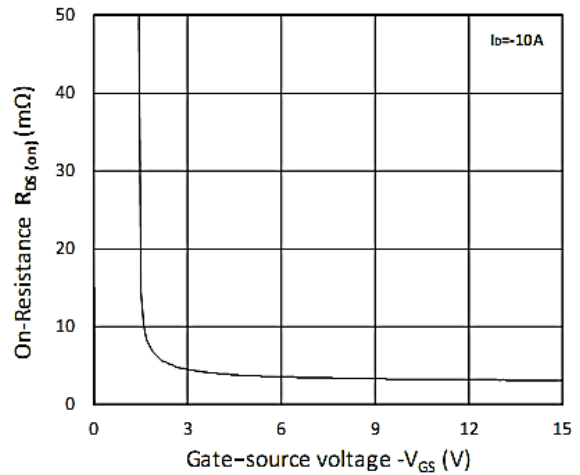

**Figure 4.  $R_{DS(ON)}$  vs.  $V_{GS}$**

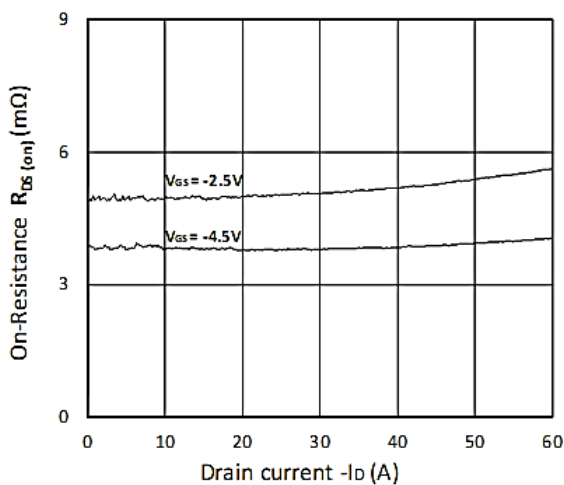

**Figure 5.  $R_{DS(ON)}$  vs.  $I_D$**

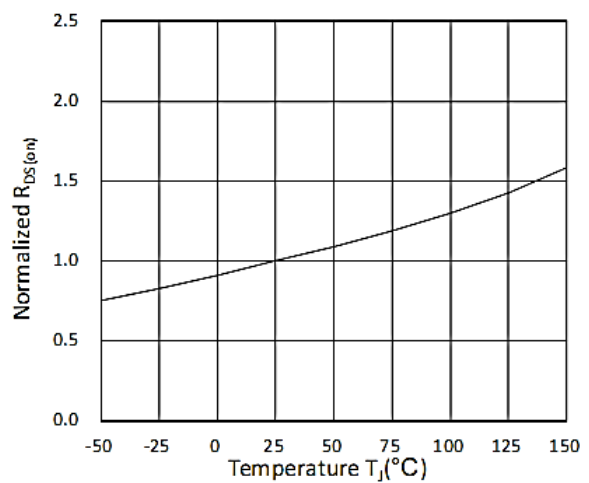

**Figure 6. Normalized  $R_{DS(on)}$  vs. Temperature**

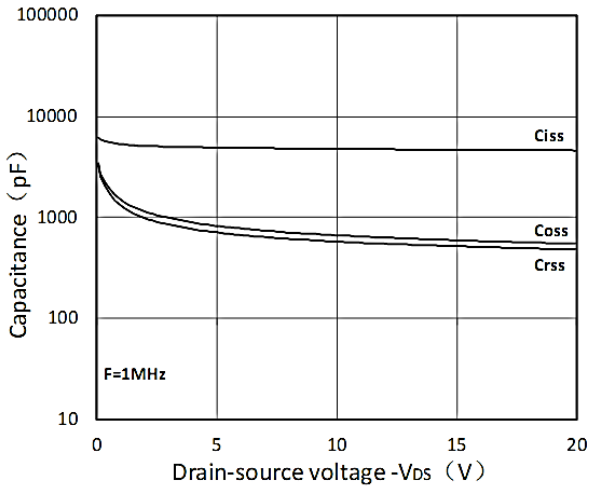

Figure 7. Capacitance Characteristics

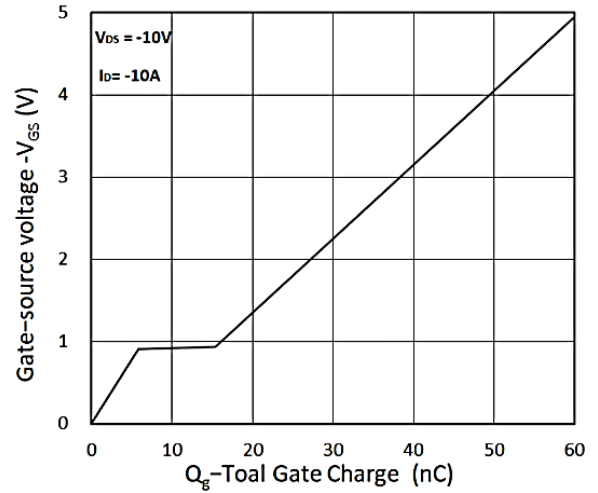

Figure 8. Gate Charge Characteristics

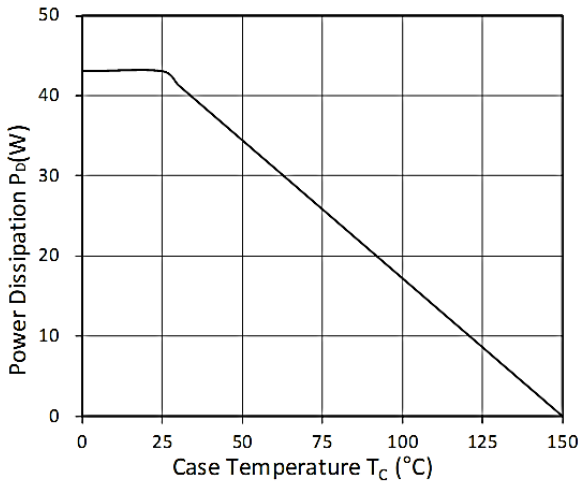

Figure 9. Power Dissipation

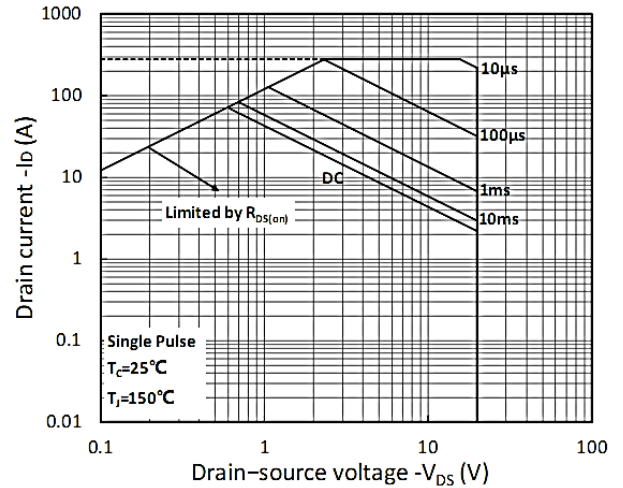

Figure 10. Safe Operating Area

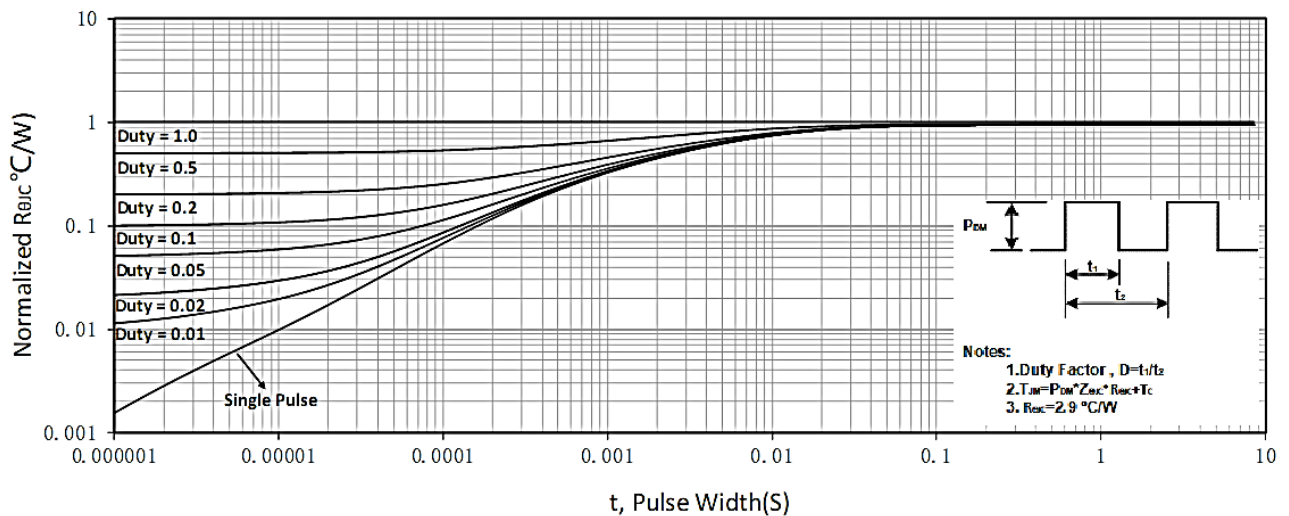
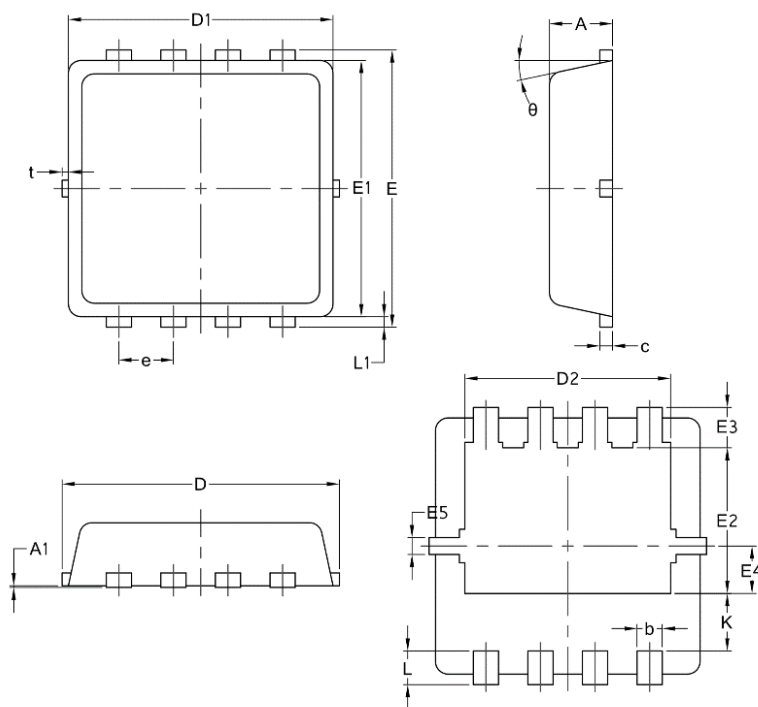

Figure 11 Normalized Maximum Transient Thermal Impedance

**Package Mechanical Data-DFN3\*3-8L-JQ Single**

Symbol	Common		
	mm		
	Mim	Nom	Max
A	0.70	0.75	0.85
A1	/	/	0.05
b	0.20	0.30	0.40
c	0.10	0.152	0.25
D	3.15	3.30	3.45
D1	3.00	3.15	3.25
D2	2.29	2.45	2.65
E	3.15	3.30	3.45
E1	2.90	3.05	3.20
E2	1.54	1.74	1.94
E3	0.28	0.48	0.65
E4	0.37	0.57	0.77
E5	0.10	0.20	0.30
e	0.60	0.65	0.70
K	0.59	0.69	0.89
L	0.30	0.40	0.50
L1	0.06	0.125	0.20
t	0	0.075	0.13
Φ	10	12	14

Flow (wave) soldering (solder dipping)

Product	Peak Temperature	Dipping Time
Pb device	245°C ±5°C	5sec±1sec
Pb-Free device	260°C +0/-5°C	5sec±1sec



This integrated circuit can be damaged by ESD. UniverChip Corporation recommends that all integrated circuits be handled with appropriate precautions. Failure to observe proper handling and installation procedure can cause damage. ESD damage can range from subtle performance degradation to complete device failure. Precision integrated circuits may be more susceptible to damage because very small parametric changes could cause the device not to meet its published specifications.

**Attention:**

- Any and all XPX power products described or contained herein do not have specifications that can handle applications that require extremely high levels of reliability, such as life-support systems, aircraft's control systems, or other applications whose failure can be reasonably expected to result in serious physical and/or material damage. Consult with your XPX power representative nearest you before using any XPX power products described or contained herein in such applications.
- XPX power assumes no responsibility for equipment failures that result from using products at values that exceed, even momentarily, rated values (such as maximum ratings, operating condition ranges, or other parameters) listed in products specifications of any and all XPX power products described or contained herein.
- Specifications of any and all XPX power products described or contained herein stipulate the performance, characteristics, and functions of the described products in the independent state, and are not guarantees of the performance, characteristics, and functions of the described products as mounted in the customer's products or equipment. To verify symptoms and states that cannot be evaluated in an independent device, the customer should always evaluate and test devices mounted in the customer's products or equipment.
- XPX power Semiconductor CO.,LTD. strives to supply high-quality high-reliability products. However, any and all semiconductor products fail with some probability. It is possible that these probabilistic failures could give rise to accidents or events that could endanger human lives, that could give rise to smoke or fire, or that could cause damage to other property. When designing equipment, adopt safety measures so that these kinds of accidents or events cannot occur. Such measures include but are not limited to protective circuits and error prevention circuits for safe design, redundant design, and structural design.
- In the event that any or all XPX power products(including technical data, services) described or contained herein are controlled under any of applicable local export control laws and regulations, such products must not be exported without obtaining the export license from the authorities concerned in accordance with the above law.
- No part of this publication may be reproduced or transmitted in any form or by any means, electronic or mechanical, including photocopying and recording, or any information storage or retrieval system, or otherwise, without the prior written permission of XPX power Semiconductor CO.,LTD.
- Information (including circuit diagrams and circuit parameters) herein is for example only ; it is not guaranteed for volume production. XPX power believes information herein is accurate and reliable, but no guarantees are made or implied regarding its use or any infringements of intellectual property rights or other rights of third parties.
- Any and all information described or contained herein are subject to change without notice due to product/ technology improvement, etc. When designing equipment, refer to the "Delivery Specification" for the XPX power product that you intend to use.
- This catalog provides information as of Sep.2019. Specifications and information herein are subject to change without notice.